

T30-XX00
PHASE CONTROL
THYRISTOR

SYMBOL	CHARACTERISTIC	TEST CONDITIONS	T _j (°C)	VALUE			UNIT
				Min	Type	Max	
I _{T(AV)}	Mean on-state current	180° half sine wave 50Hz Double side cooled, T _{hs} =55°C	125			3790	A
I _{T(AV)}	Mean on-state current	180° half sine wave 50Hz Double side cooled, T _{hs} =80°C	125			2802	A
V _{DRM} V _{RRM}	Repetitive peak off-state voltage Repetitive peak reverse voltage	V _{DRM} &V _{RRM} tp=10ms V _{Dsm} &V _{Rsm} = V _{DRM} &V _{RRM} +100V respectively	125	800		1800	V
I _{DRM} I _{RRM}	Repetitive peak current	at V _{DRM} at V _{RRM}	125			200	mA
I _{TSM}	Surge on-state current	10ms half sine wave	125			49.9	KA
I ² T	I ² T for fusing coordination	V _R =0.6V _{RRM}				12428	A ² s*10 ³
V _{TO}	Threshold voltage		125			0.84	V
r _T	On-state slop resistance					0.09	mΩ
V _{TM}	Peak on-state voltage	I _{TM} =5000A, F=40KN	125			1.29	V
dv/dt	Critical rate of rise of off-state voltage	V _{DM} =0.67V _{DRM}	125			500	V/μs
di/dt	Critical rate of rise of on-state current	From 67%V _{DRM} to 2000A, Gate source 1.5A t _r ≤0.5μs Repetitive	125			400	A/μs
I _{rm}	Reverse recovery current					250	A
t _{rr}	Reverse recovery time	I _{TM} =1500A, tp=1000μs, di/dt=-20A/μs, V _r =50V	125			24	μs
Q _{rr}	Recovery charge					3000	μC
I _{GT}	Gate trigger current			40		300	mA
V _{GT}	Gate trigger voltage	V _A =12V, I _A =1A	25	0.8		3.0	V
I _H	Holding current			20		300	mA
V _{GD}	Non-trigger gate voltage	At 67%V _{DRM}	125			0.3	V
R _{th(j-h)}	Thermal resistance Junction to heatsink	At 180° sine' double side cooled Clamping force 40KN				0.011	°C /W
F _m	Mounting force			35		47	KN
T _{stg}	Stored temperature			-40		140	°C
W _t	Weight				1100		g
Outline	KT73cT						

Outline

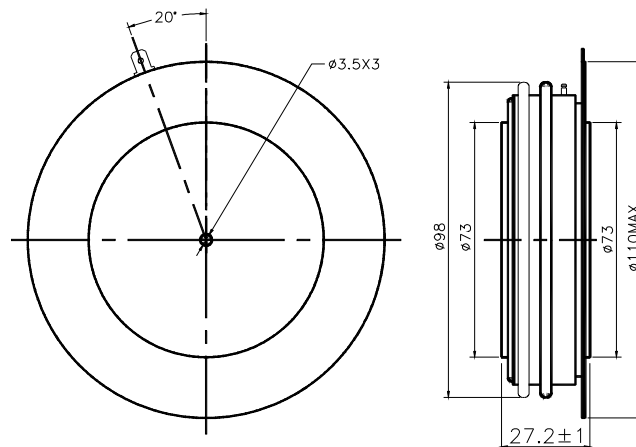

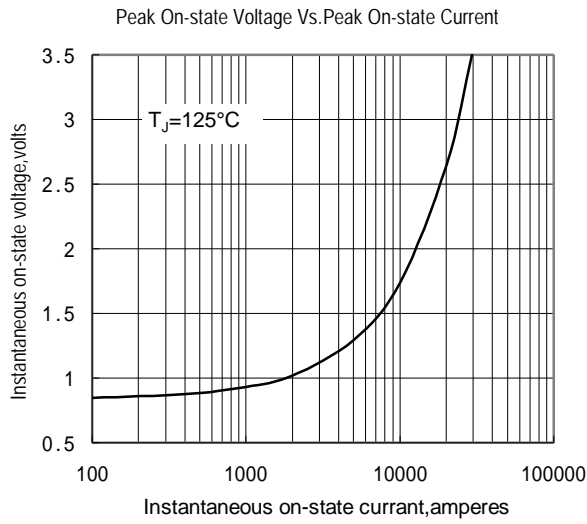

Fig.1

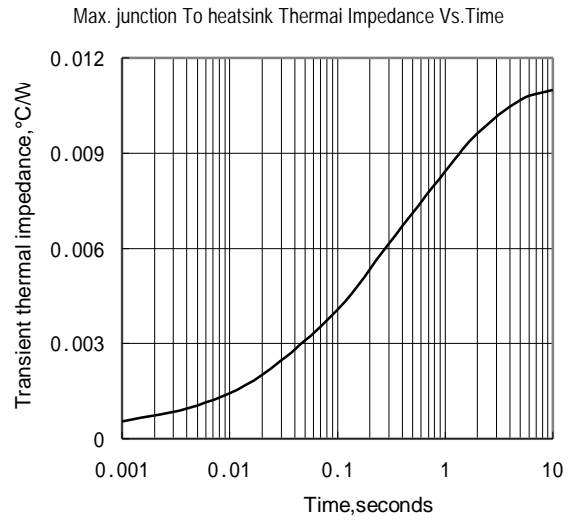

Fig.2

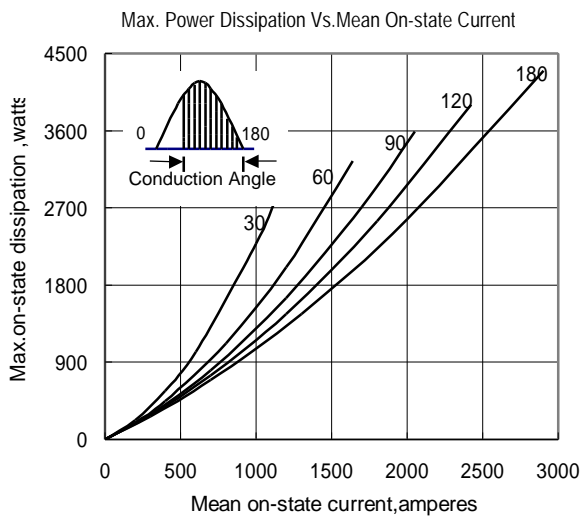

Fig.3

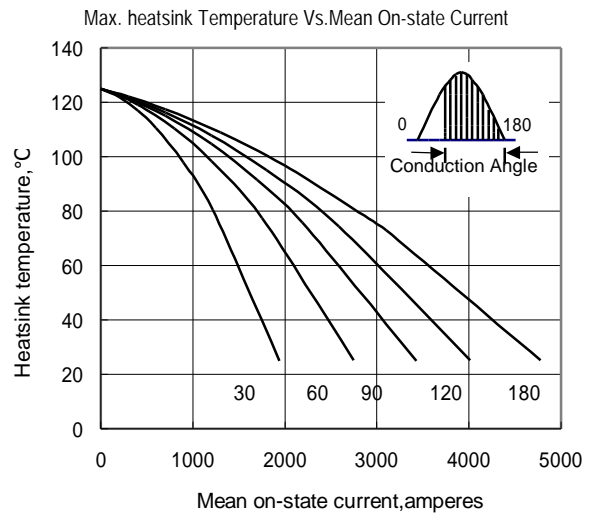

Fig.4

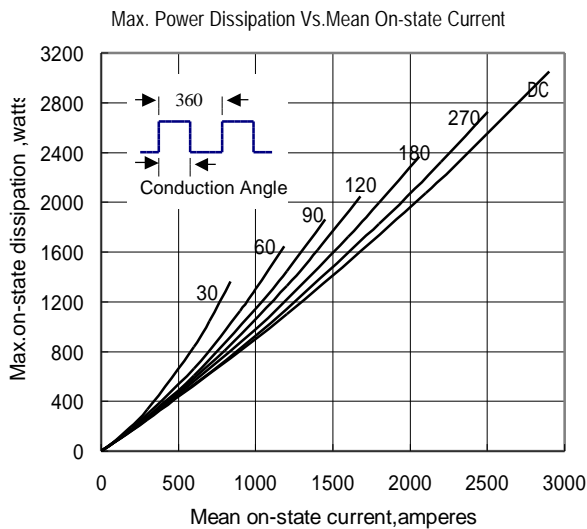

Fig.5

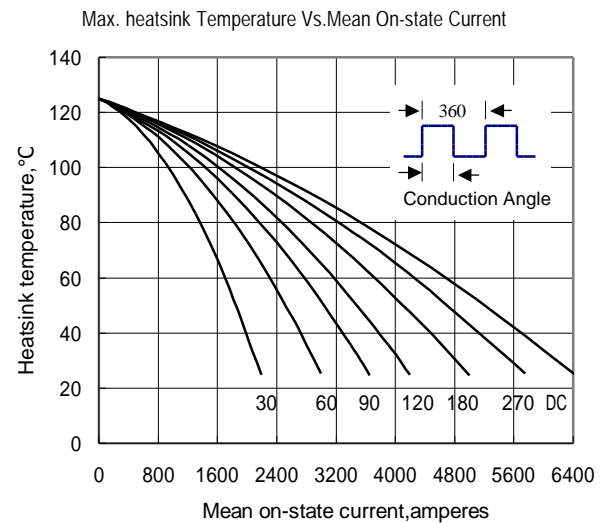

Fig.6

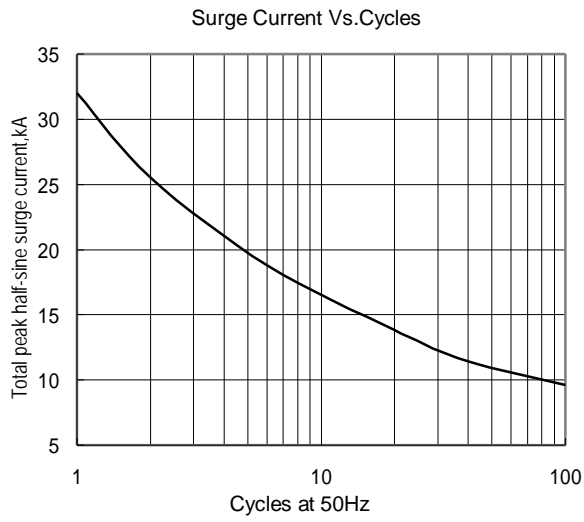

Fig.7

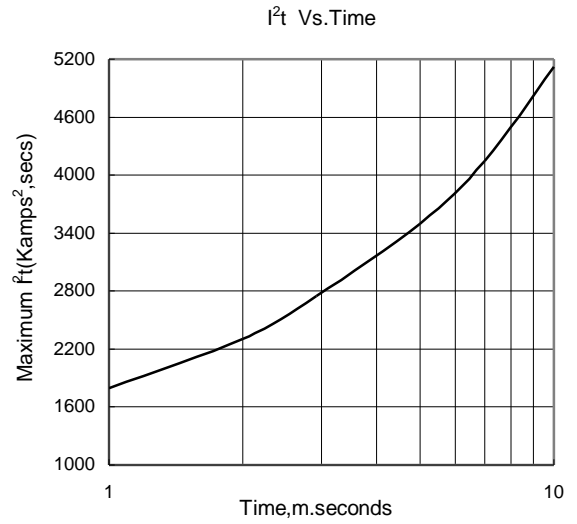

Fig.8

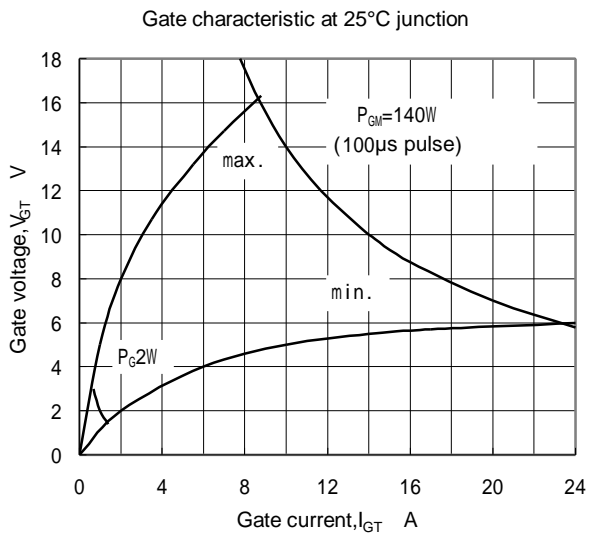

Fig.9

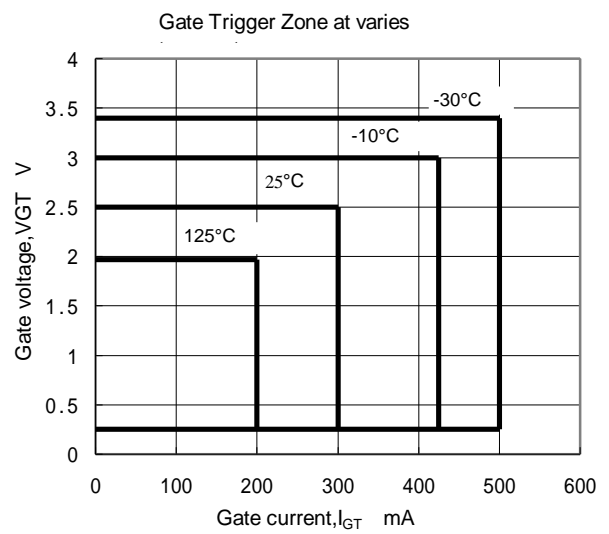

Fig.10