

TD110 ATD110 KTD110 DT110 ADT110 KDT110

SYMBOL	CHARACTERISTIC	TEST CONDITIONS	T _j (°C)	VALUE			UNIT
				Min	Type	Max	
I _{T(AV)} I _{F(AV)}	Mean on-state current	180° half sine wave 50Hz Single side cooled, T _C =85°C	125			110	A
I _{T(RMS)}	RMS on-state current	Single side cooled, T _C =85°C	125			173	A
V _{DRM} V _{RRM}	Repetitive peak off-state voltage Repetitive peak reverse voltage	V _{DRM} &V _{RRM} tp=10ms V _{Dsm} &V _{Rsm} = V _{DRM} &V _{RRM} +200V respectively	125	600		1600	V
I _{DRM} I _{RRM}	Repetitive peak current	at V _{DRM} at V _{RRM}	125			12	mA
I _{TSM}	Surge on-state current	10ms half sine wave	125			2.40	KA
I ² t	I ² T for fusing coordination	V _R =60%V _{RRM}				29.3	A ² s*10 ³
V _{TO}	Threshold voltage		125			0.8	V
r _T	On-state slop resistance					2.29	mΩ
V _{TM}	Peak on-state voltage	I _{TM} =330A	125			1.69	V
dv/dt	Critical rate of rise of off-state voltage	V _{DM} =67%V _{DRM}	125			800	V/μs
di/dt	Critical rate of rise of on-state current	From 67%V _{DRM} to 330A, Gate source 1.5A t _r ≤0.5μs Repetitive	125			100	A/μs
I _{GT}	Gate trigger current			30		100	mA
V _{GT}	Gate trigger voltage	V _A =12V, I _A =1A	25	1.0		2.0	V
I _H	Holding current			20		100	mA
V _{GD}	Non-trigger gate voltage	At 67%V _{DRM}	125			0.2	V
R _{th(j-c)}	Thermal resistance Junction to heatsink	At 180° sine' Single side cooled				0.250	°C /W
V _{iso}	Isolation voltage	50Hz, R.M.S, t=1min, I _{iso} :1mA(MAX)		2500			V
F _m	Thermal connection torque(M5)				0.2		N·m
	Mounting torque(M6)				0.3		N·m
T _{stg}	Stored temperature			-40		140	°C
W _t	Weight				160		g
Outline	202F3						

OUTLINE DRAWING & CIRCUIT DIAGRAM

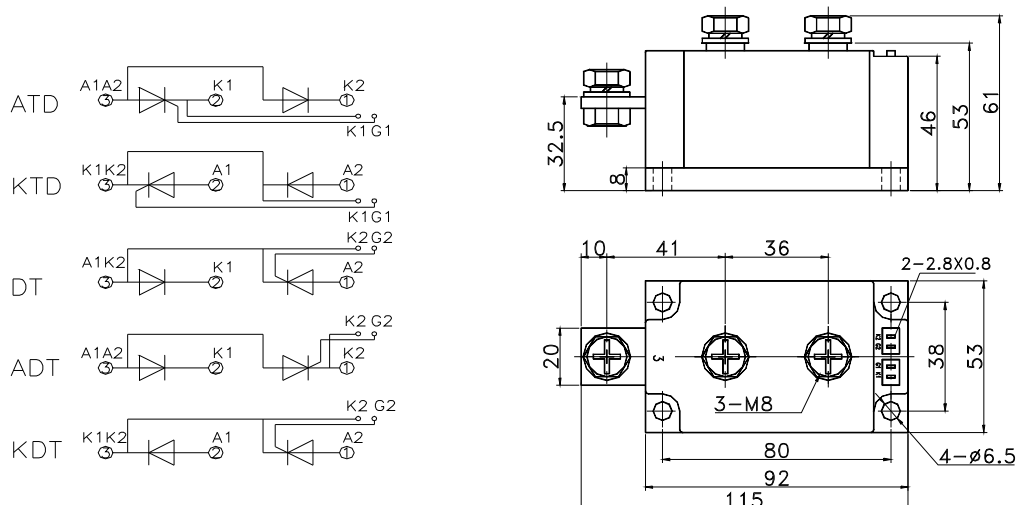

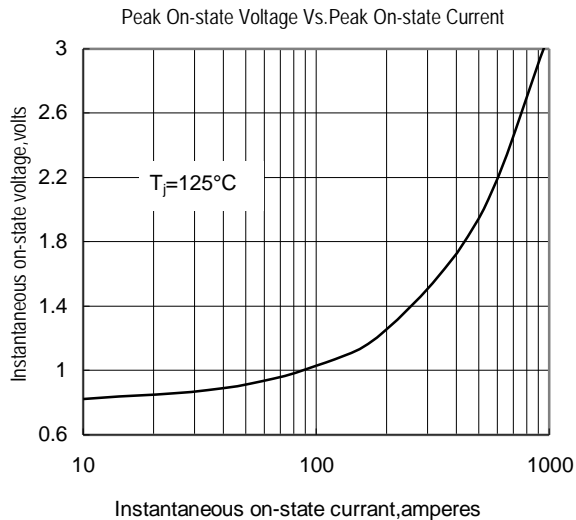

Fig.1

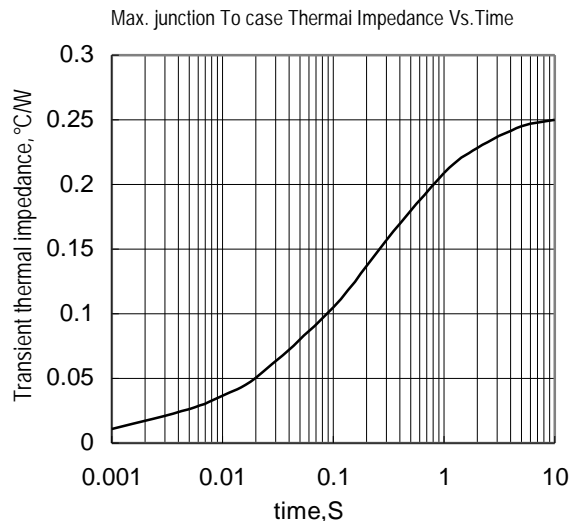

Fig.2

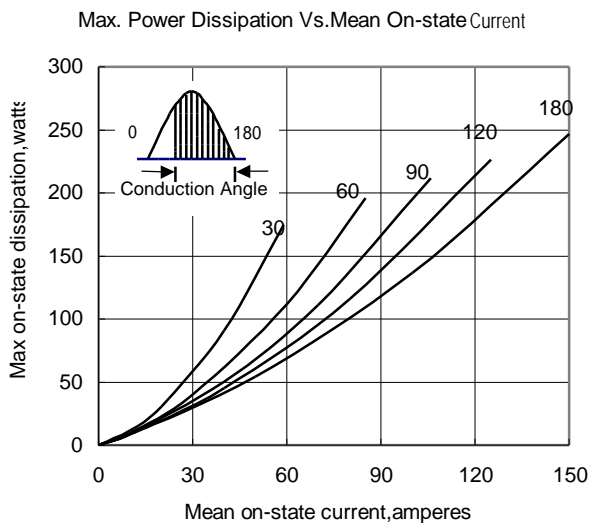

Fig.3

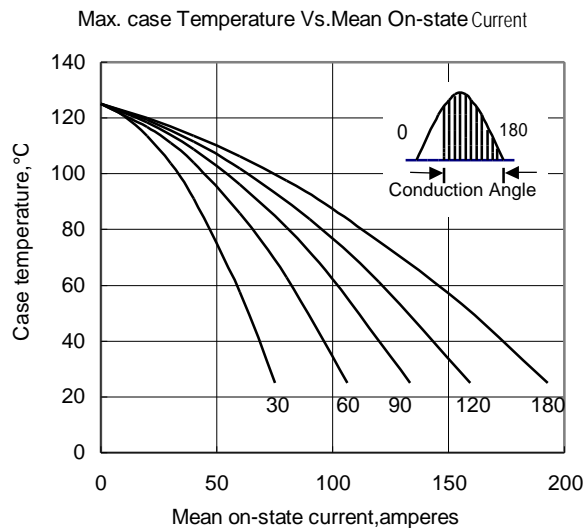

Fig.4

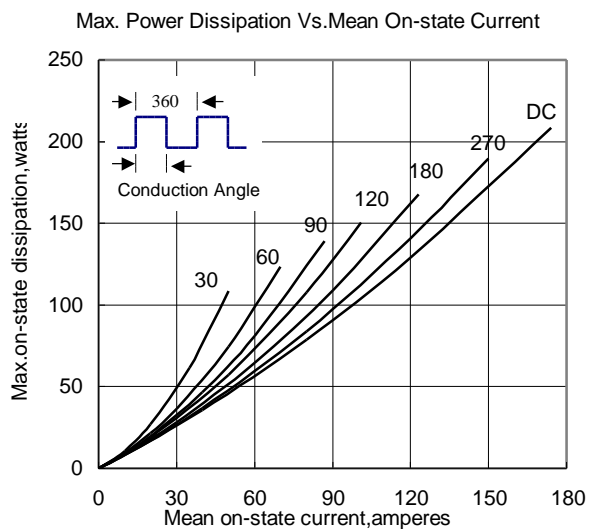

Fig.5

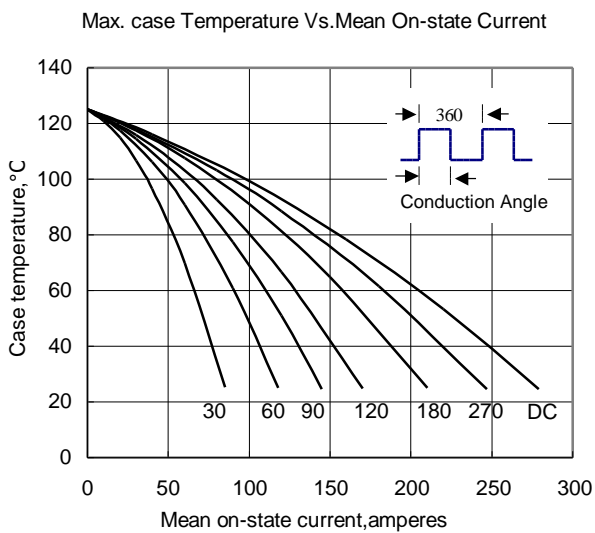

Fig.6

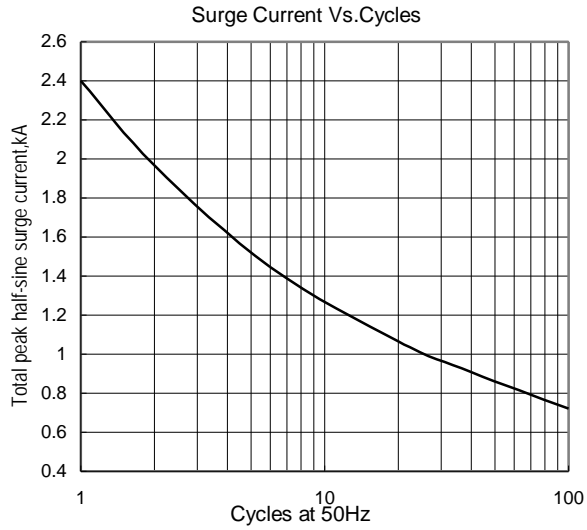

Fig.7

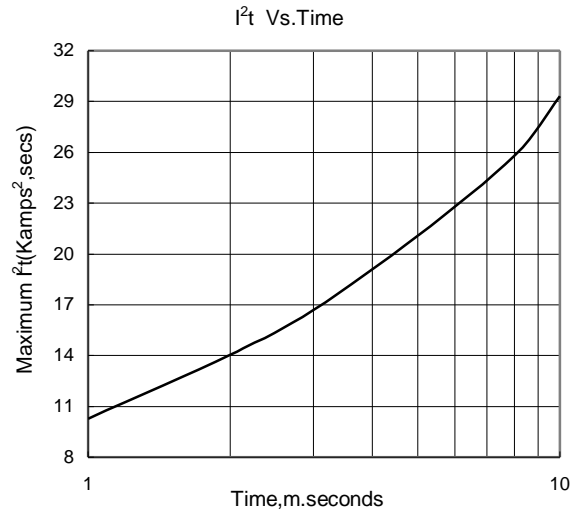

Fig.8

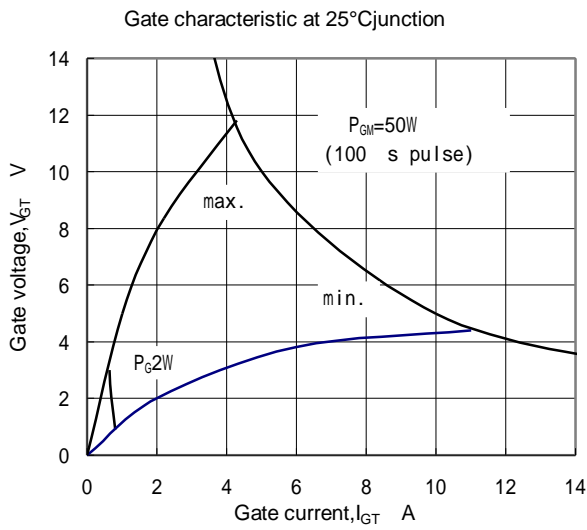

Fig.9

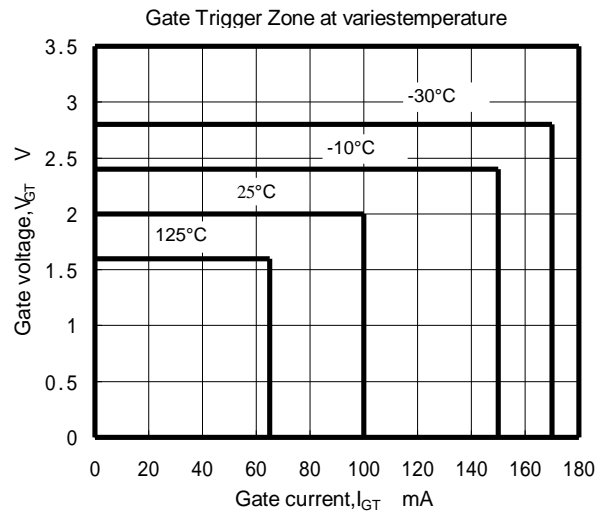

Fig.10