

DD250 ADD250 KDD250

SYMBOL	CHARACTERISTIC	TEST CONDITIONS	T _j (°C)	VALUE			UNIT
				Min	Type	Max	
I _{F(AV)}	Mean forward current	180° half sine wave 50Hz Single side cooled, T _C =100°C	150			250	A
I _{F(RMS)}	RMS forward current	Single side cooled, T _C =100°C	150			393	A
V _{RRM}	Repetitive peak reverse voltage	V _{RRM} tp=10ms V _{RSM} = V _{DRM} &V _{RRM} +200V	150	600		1800	V
I _{RRM}	Repetitive peak current	at V _{RRM}	150			20	mA
I _{FSM}	Surge forward current	10ms half sine wave	150			11.0	KA
I ² t	I ² T for fusing coordination	V _R =0.6V _{RRM}				617	A ² s*10 ³
V _{FO}	Threshold voltage		150			0.75	V
r _F	Forward slop resistance					0.76	mΩ
V _{FM}	Peak forward voltage	I _{FM} =750A	25			1.43	V
R _{th(j-c)}	Thermal resistance Junction to heatsink	At 180° sine Single side cooled				0.140	°C /W
V _{iso}	Isolation voltage	50Hz, R.M.S, t=1min, I _{iso} : 1mA(max)		2500			V
F _m	Terminal connection torque(M5)					4.5	N·m
	Mounting torque(M6)					3.0	N·m
T _{stg}	Stored temperature			-40		125	°C
W _t	Weight					930	g
Outline	401F3						

OUTLINE DRAWING & CIRCUIT DIAGRAM

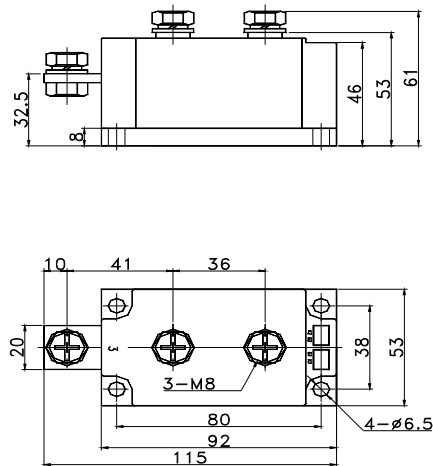
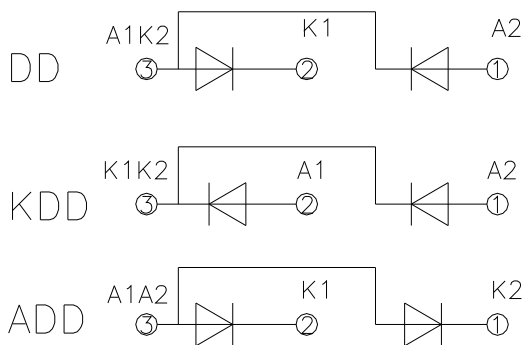

Peak forward Voltage Vs. Peak forward Current

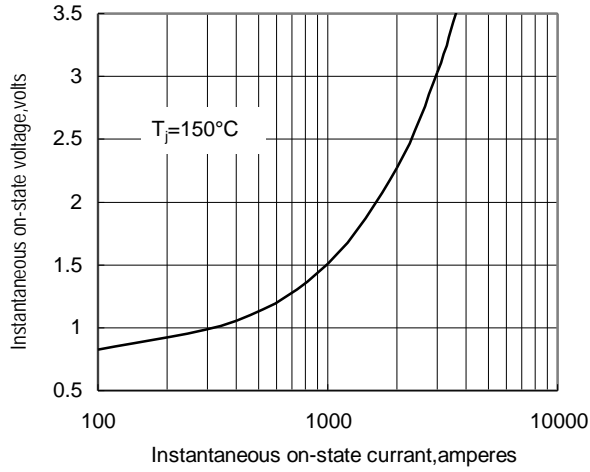

Fig.1

Max. junction To case Thermal Impedance Vs. Time

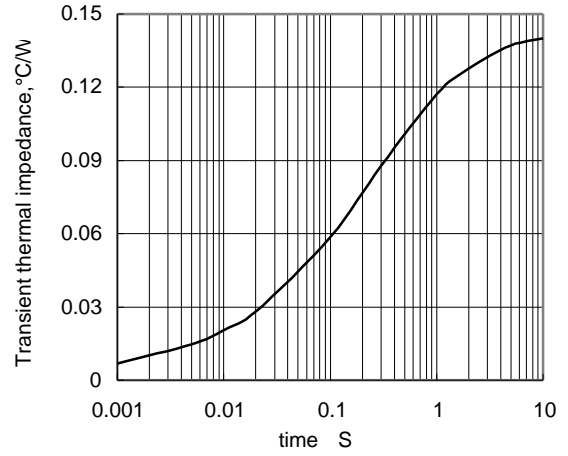

Fig.2

Max. Power Dissipation Vs. Mean forward Current

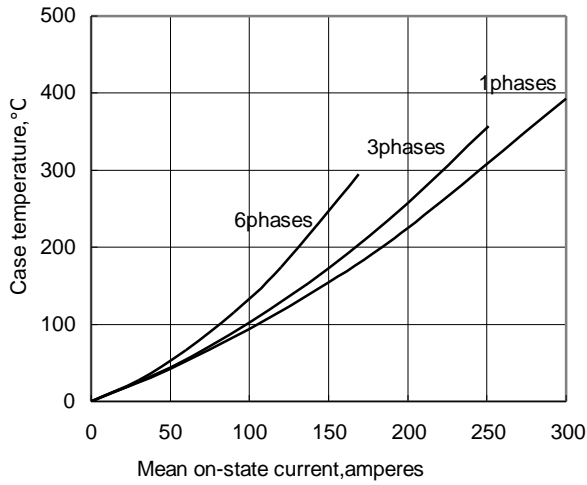

Fig.3

Max. case Temperature Vs. Mean forward Current

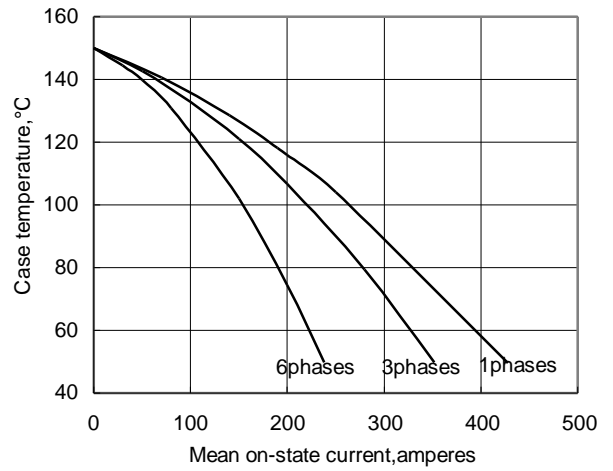

Fig.4

Max. Power Dissipation Vs. Mean forward Current

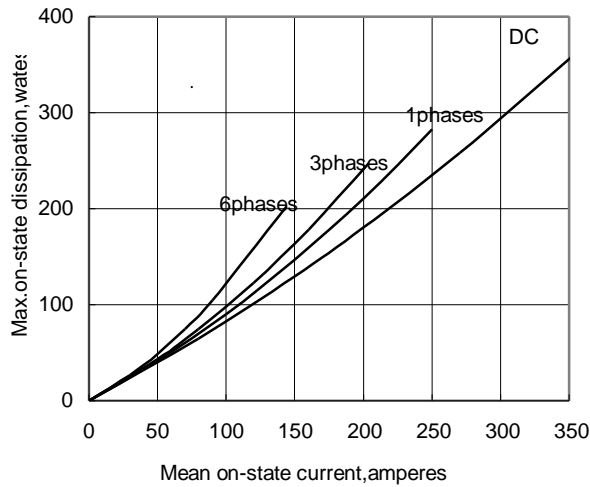

Fig.5

Max. case Temperature Vs. Mean forward Current

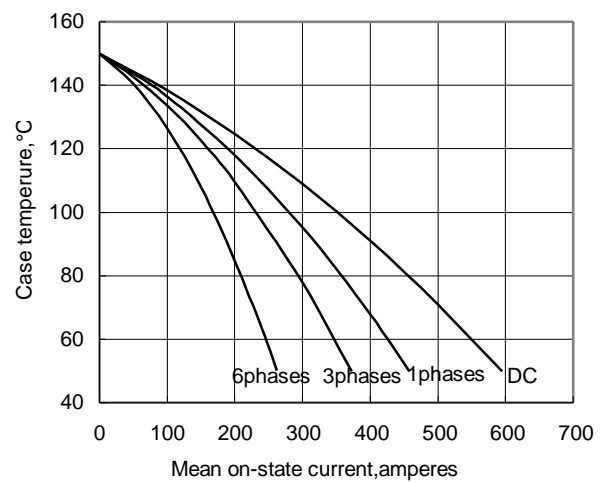

Fig.6