

SYMBOL	CHARACTERISTIC	TEST CONDITIONS	T <sub>j</sub> (°C)	VALUE			UNIT	
				Min	Type	Max		
I <sub>F(AV)</sub>	Mean forward current	180° half sine wave 50Hz Double side cooled, T <sub>hs</sub> =55°C	150			2815	A	
I <sub>F(AV)</sub>	Mean forward current	180° half sine wave 50Hz Double side cooled, T <sub>hs</sub> =90°C	150			2072	A	
V <sub>RRM</sub>	Repetitive peak reverse voltage	V <sub>RRM</sub> tp=10ms V <sub>RSM</sub> = V <sub>RRM</sub> +100V	150	1100		2000	V	
I <sub>RRM</sub>	Repetitive peak current	at V <sub>RRM</sub>	150			100	mA	
I <sub>FSM</sub>	Surge forward current	10ms half sine wave	150			36.6	KA	
I <sup>2</sup> T	I <sup>2</sup> T for fusing coordination	V <sub>R</sub> =0.6V <sub>RRM</sub>					6696	A <sup>2</sup> s*10 <sup>3</sup>
V <sub>FO</sub>	Threshold voltage		150			0.78	V	
r <sub>F</sub>	Forward slop resistance						0.13	mΩ
V <sub>FM</sub>	Peak on-state voltage	I <sub>TM</sub> =4500A, F=26KN	150			1.37	V	
I <sub>rm</sub>	Reverse recovery current		150			140	A	
t <sub>rr</sub>	Reverse recovery time	I <sub>TM</sub> =1000A, tp=1000μs, di/dt=-40A/μs, V <sub>R</sub> =50V					6.0	μs
Q <sub>rr</sub>	Recovery charge						420	μC
R <sub>th(j-h)</sub>	Thermal resistance Junction to heatsink	At 180° sine double side cooled Clamping force 26KN				0.020	°C /W	
F <sub>m</sub>	Mounting force			21		30	KN	
T <sub>stg</sub>	Stored temperature			-40		160	°C	
W <sub>t</sub>	Weight				620		g	
Outline	ZT54cT55							

Outline

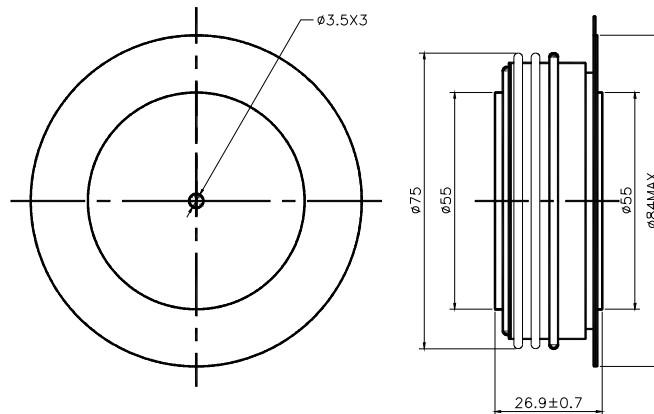

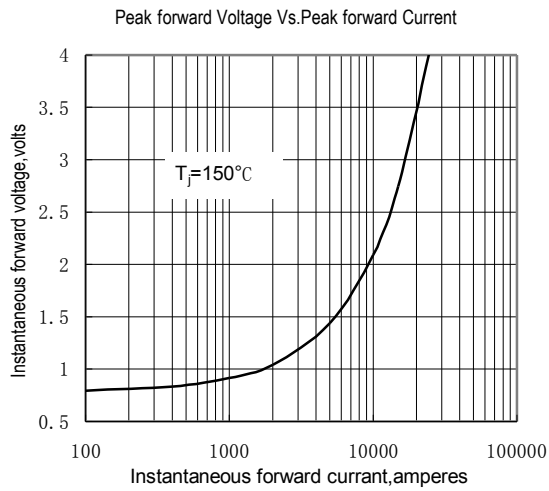

Fig.1

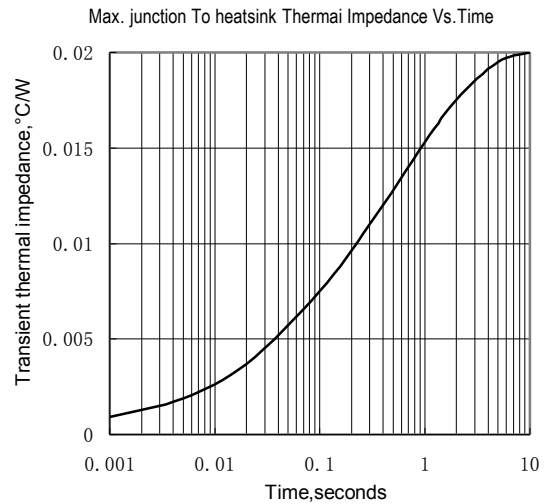

Fig.2

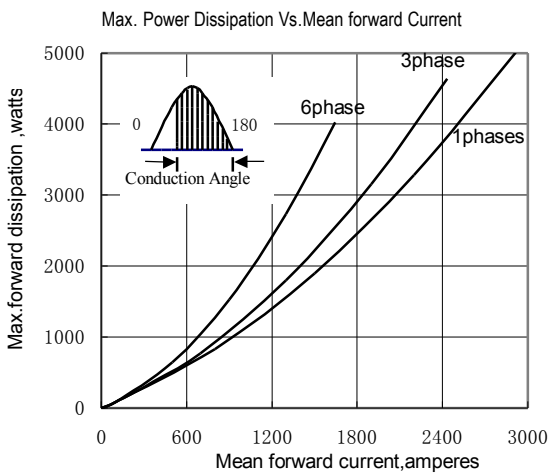

Fig.3

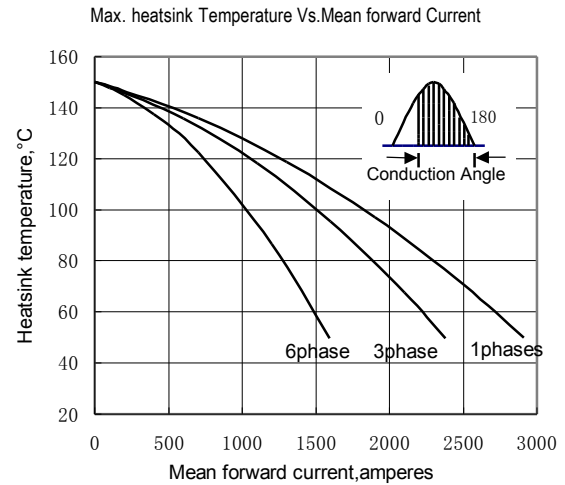

Fig.4

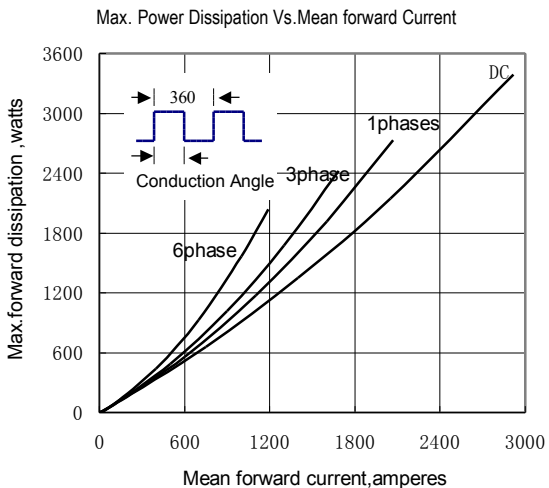

Fig.5

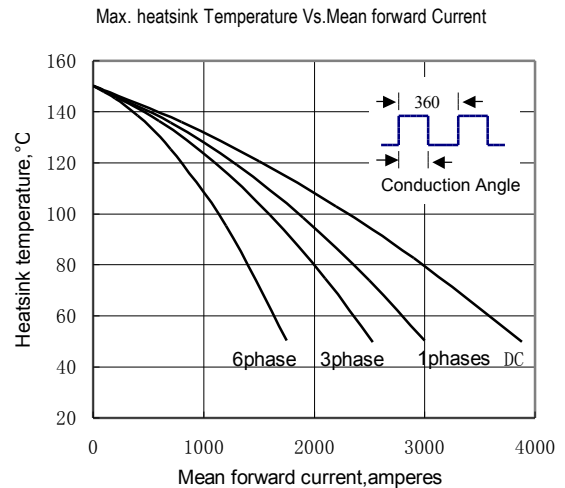

Fig.6

D16-XX00  
RECTIFIER DIODE

---