

SYMBOL	CHARACTERISTIC	TEST CONDITIONS	T _j (°C)	VALUE			UNIT	
				Min	Type	Max		
I _{F(AV)}	Mean forward current	180° half sine wave 50Hz Double side cooled, T _{HS} =55°C	150			1476	A	
I _{F(AV)}	Mean forward current	180° half sine wave 50Hz Double side cooled, T _{HS} =90°C	150			1078	A	
V _{RRM}	Repetitive peak reverse voltage	V _{RRM} tp=10ms V _{RSM} = V _{RRM} +100V	150	200		1000	V	
I _{RRM}	Repetitive peak current	at V _{RRM}	150			40	mA	
I _{FSM}	Surge forward current	10ms half sine wave	150			19.2	KA	
I ² T	I ² T for fusing coordination	V _R =0.6V _{RRM}					1841	A ² s*10 ³
V _{FO}	Threshold voltage		150			0.97	V	
r _F	Forward slop resistance						0.27	mΩ
V _{FM}	Peak on-state voltage	I _{TM} =2870A, F=15KN	150			1.74	V	
I _m	Reverse recovery current		150			82.9	A	
t _{rr}	Reverse recovery time	I _{TM} =1000A, tp=1000μs, di/dt=-40A/μs, V _R =50V					4.0	μs
Q _{rr}	Recovery charge						165	μC
R _{th(j-h)}	Thermal resistance Junction to heatsink	At 180° sine double side cooled Clamping force 15KN				0.033	°C /W	
F _m	Mounting force			10		20	KN	
T _{stg}	Stored temperature			-40		160	°C	
W _t	Weight				260		g	
Outline	ZT33cT							

Outline

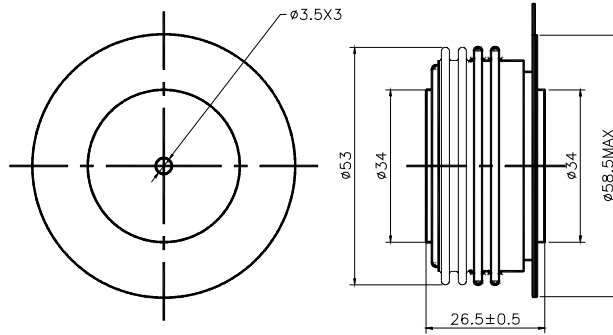

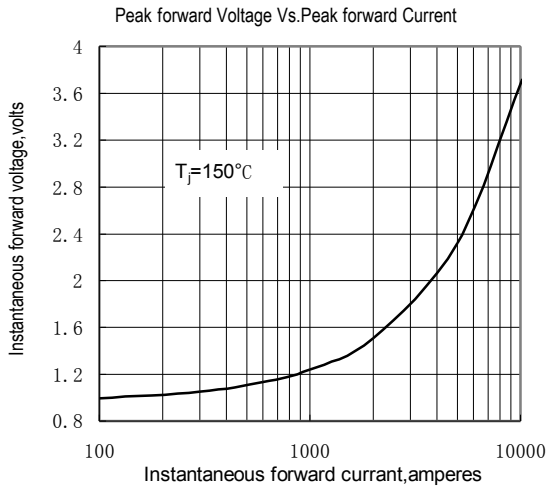

Fig.1

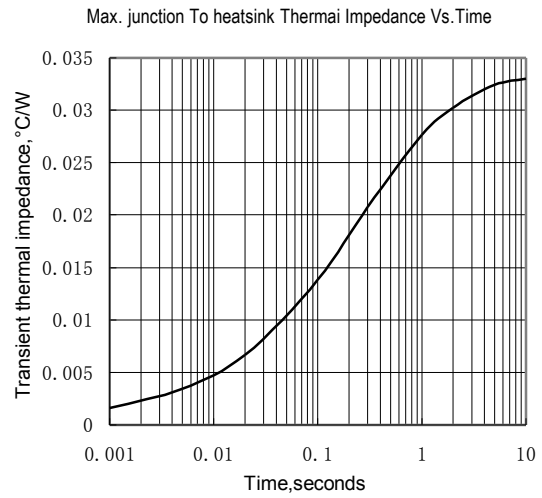

Fig.2

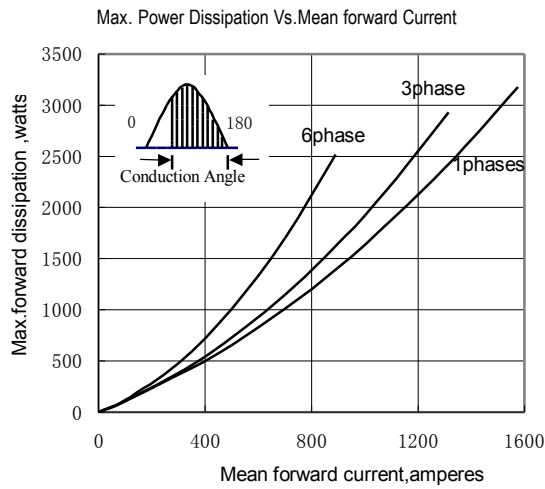

Fig.3

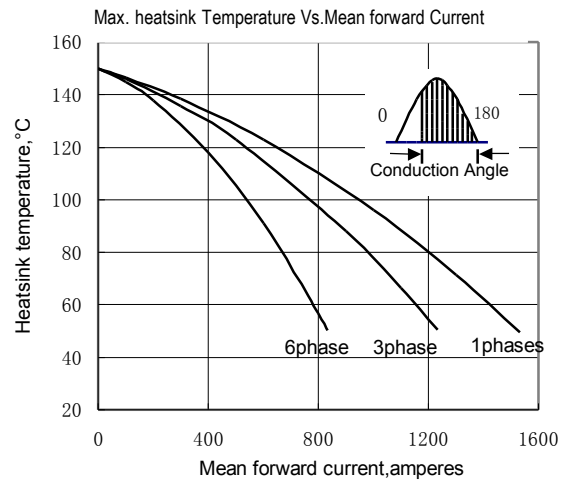

Fig.4

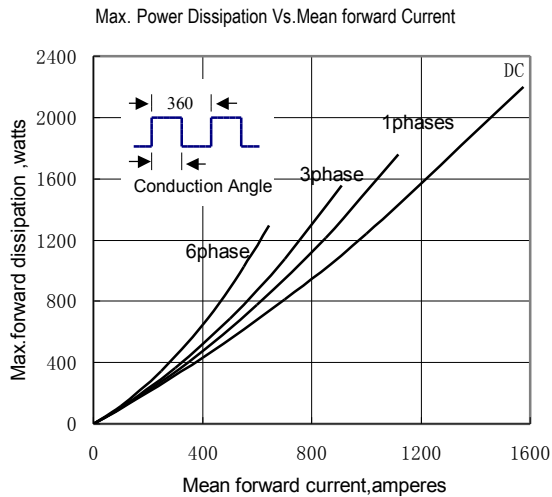

Fig.5

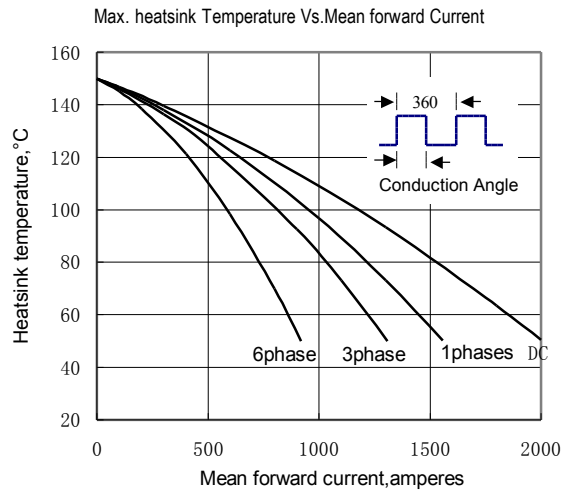

Fig.6