

SYMBOL	CHARACTERISTIC	TEST CONDITIONS	T _J (°C)	VALUE			UNIT	
				Min	Type	Max		
I _{F(AV)}	Mean forward current	180° half sine wave 50Hz Double side cooled, T _{HS} =55°C	150			560	A	
I _{F(AV)}	Mean forward current	180° half sine wave 50Hz Double side cooled, T _{HS} =90°C	150			420	A	
V _{RRM}	Repetitive peak reverse voltage	V _{RRM} tp=10ms V _{RSM} = V _{RRM} +100V	150	1100		2000	V	
I _{RRM}	Repetitive peak current	at V _{RRM}	150			16	mA	
I _{FSM}	Surge forward current	10ms half sine wave	150			7.3	KA	
I ² T	I ² T for fusing coordination	V _R =0.6V _{RRM}					265	A ² s*10 ³
V _{FO}	Threshold voltage		150			0.70	V	
r _F	Forward slop resistance						0.86	mΩ
V _{FM}	Peak on-state voltage	I _{TM} =1500A, F=5KN	150			1.99	V	
I _m	Reverse recovery current		150			74.8	A	
t _{rr}	Reverse recovery time	I _{TM} =600A, tp=1000μs, di/dt=-40A/μs, V _R =50V					4.0	μs
Q _{rr}	Recovery charge						159.7	μC
R _{th(j-h)}	Thermal resistance Junction to heatsink	At 180° sine double side cooled Clamping force 5.0KN				0.090	°C /W	
F _m	Mounting force			3.3		5.5	KN	
T _{stg}	Stored temperature			-40		160	°C	
W _t	Weight				50		g	
Outline	ZT19aT							

Outline

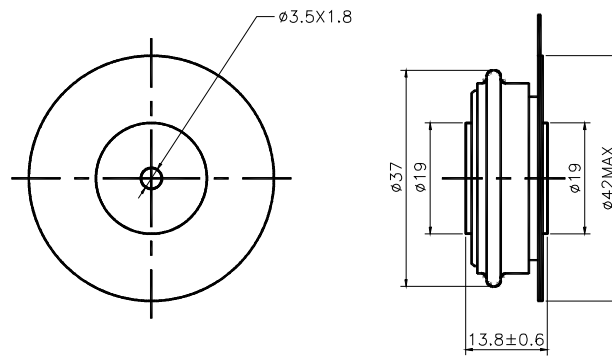

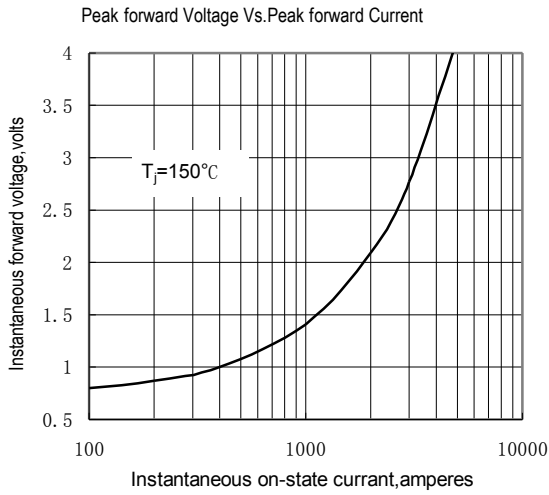

Fig.1

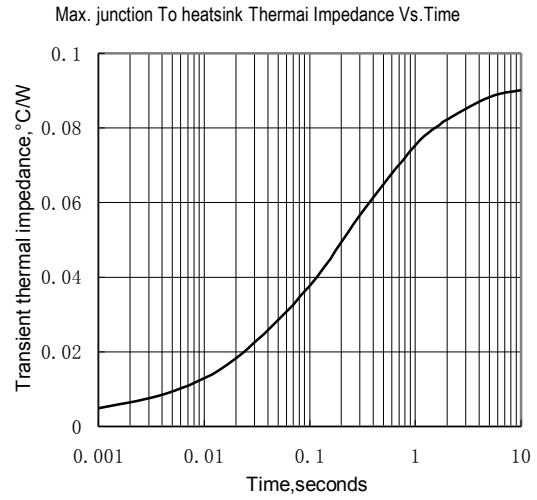

Fig.2

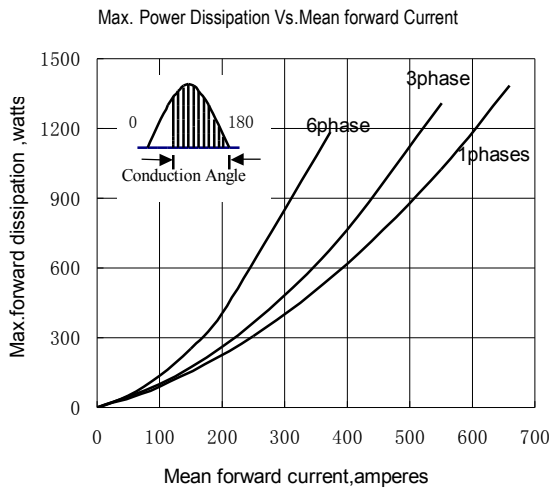

Fig.3

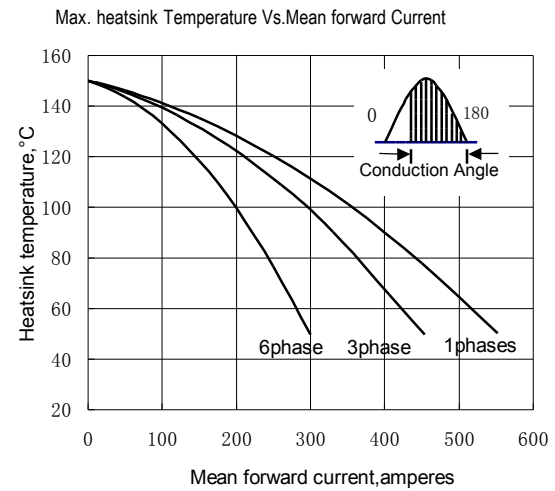

Fig.4

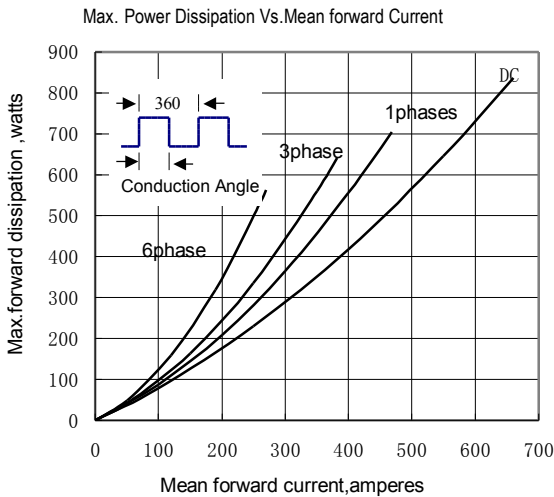

Fig.5

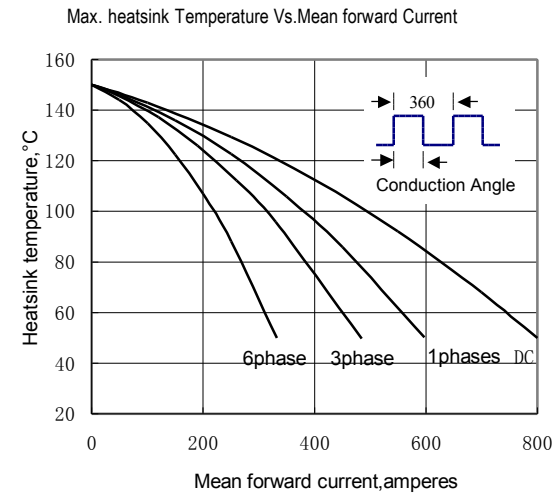

Fig.6